

1/24

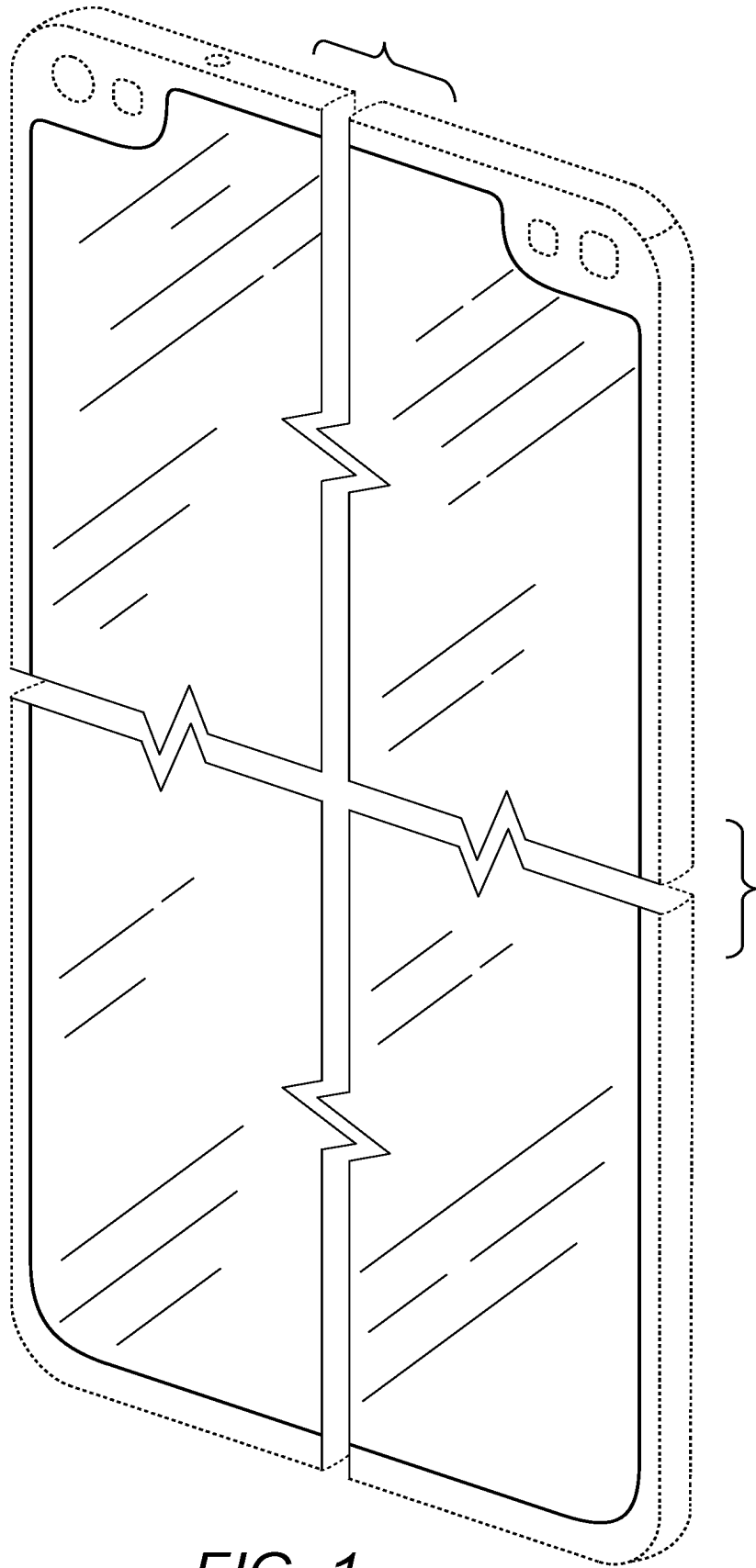

FIG. 1

2/24

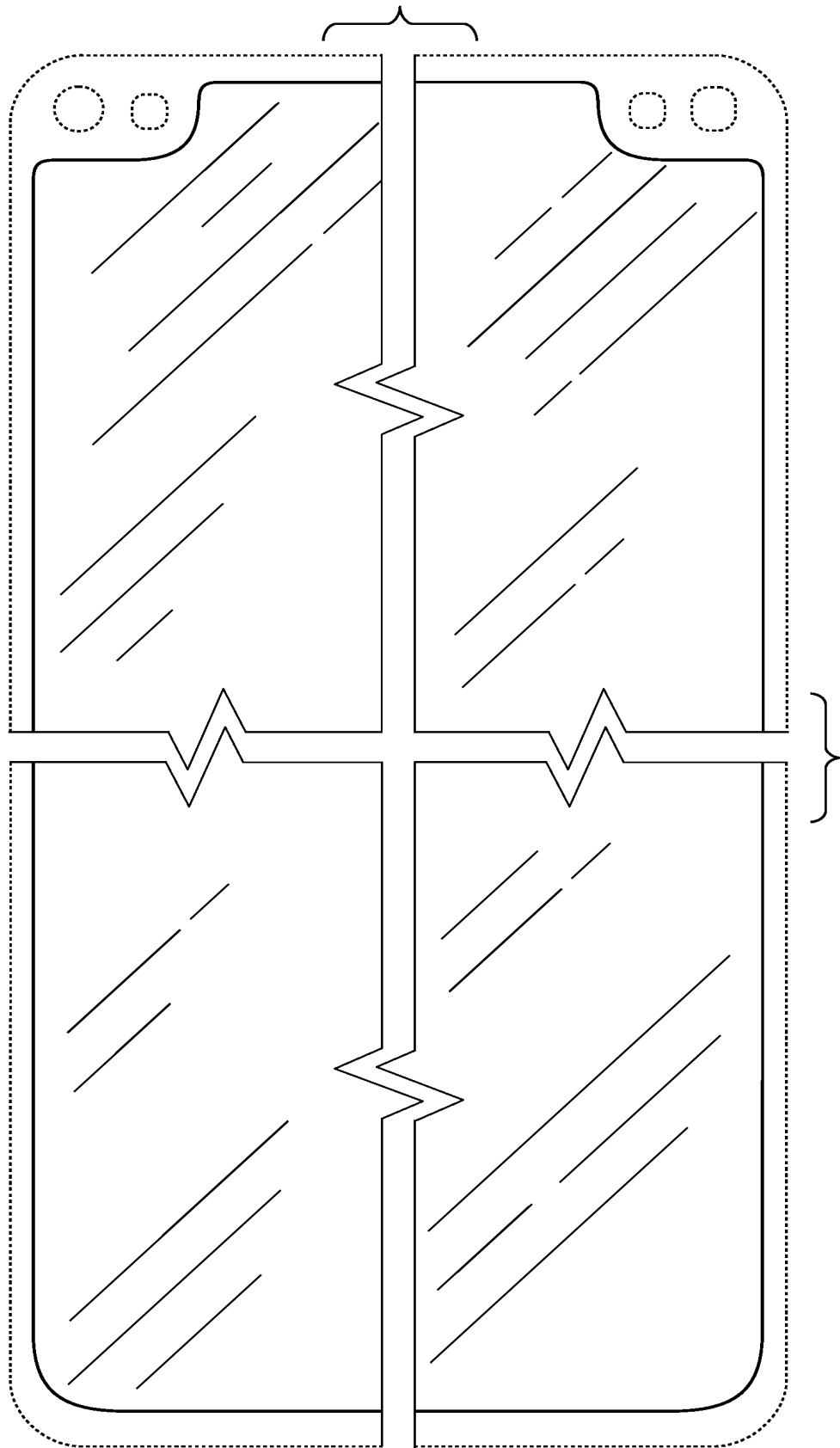

FIG. 2

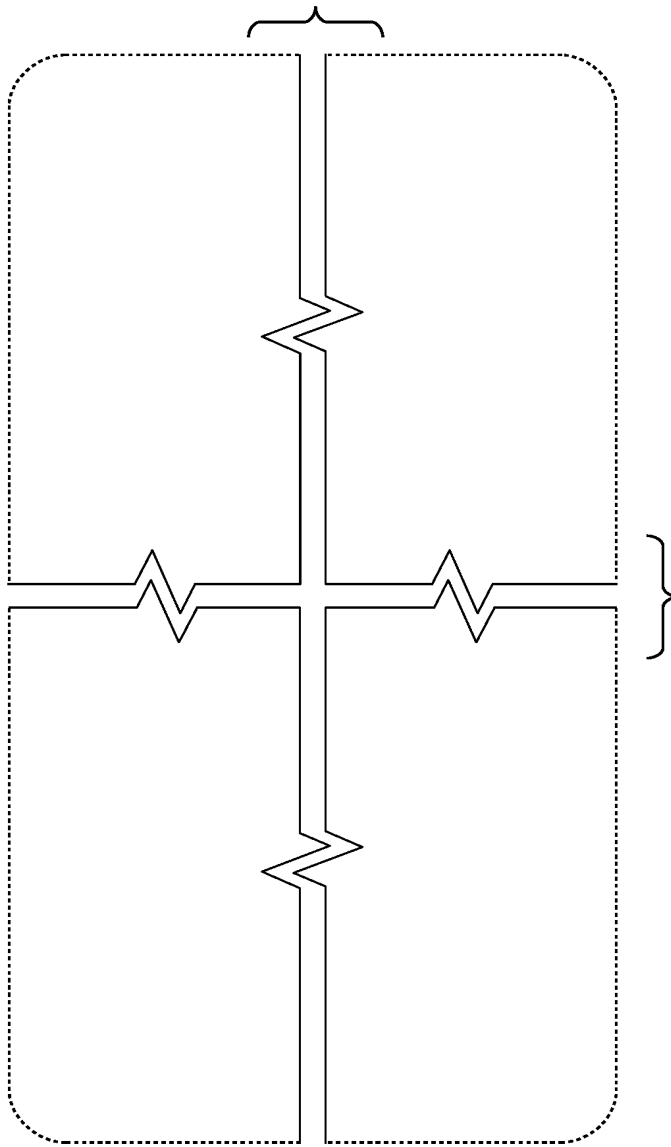

FIG. 3

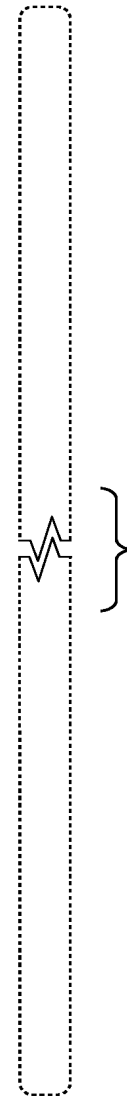

FIG. 4



FIG. 5



FIG. 6

4/24

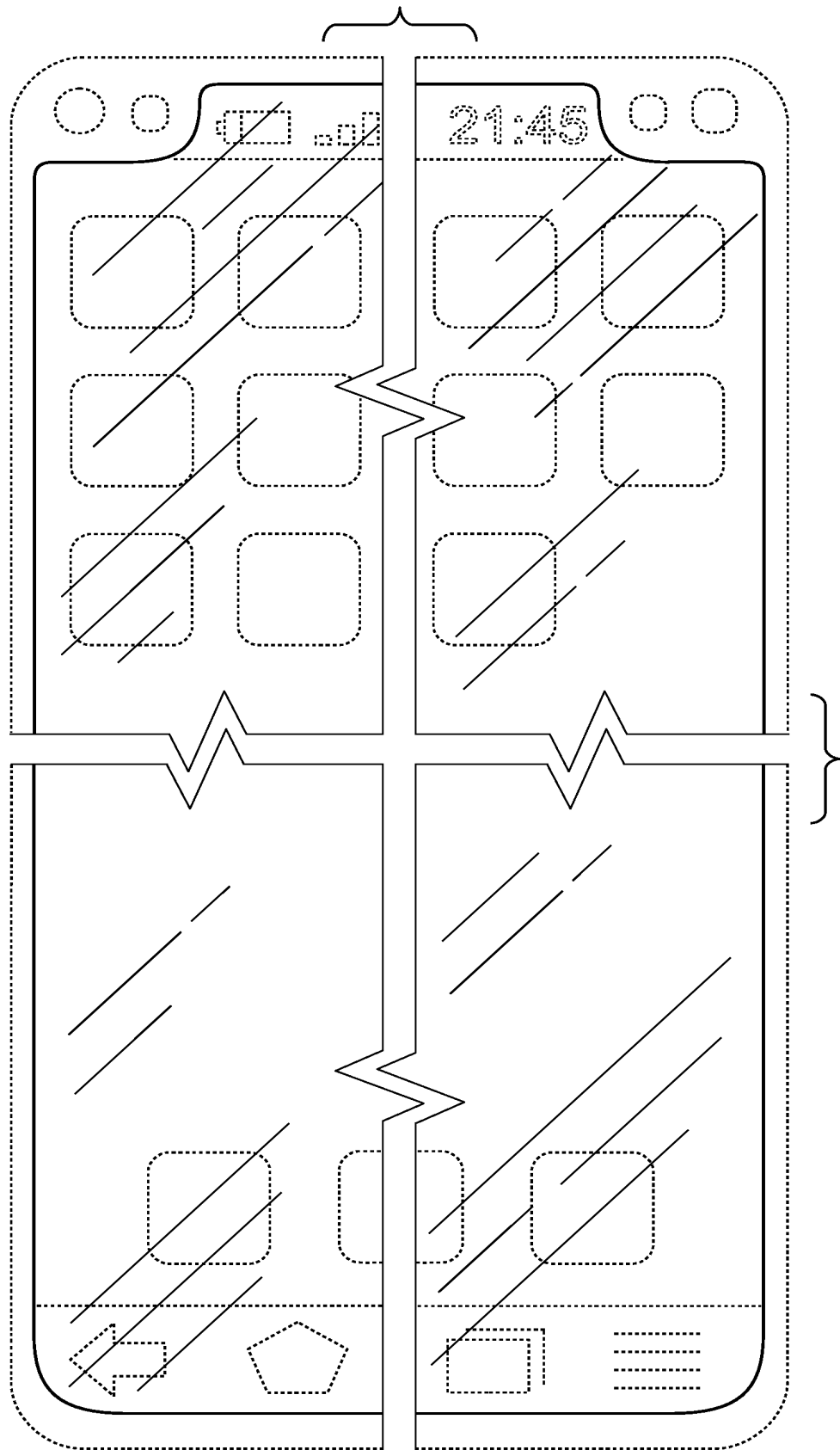

FIG. 7

5/24

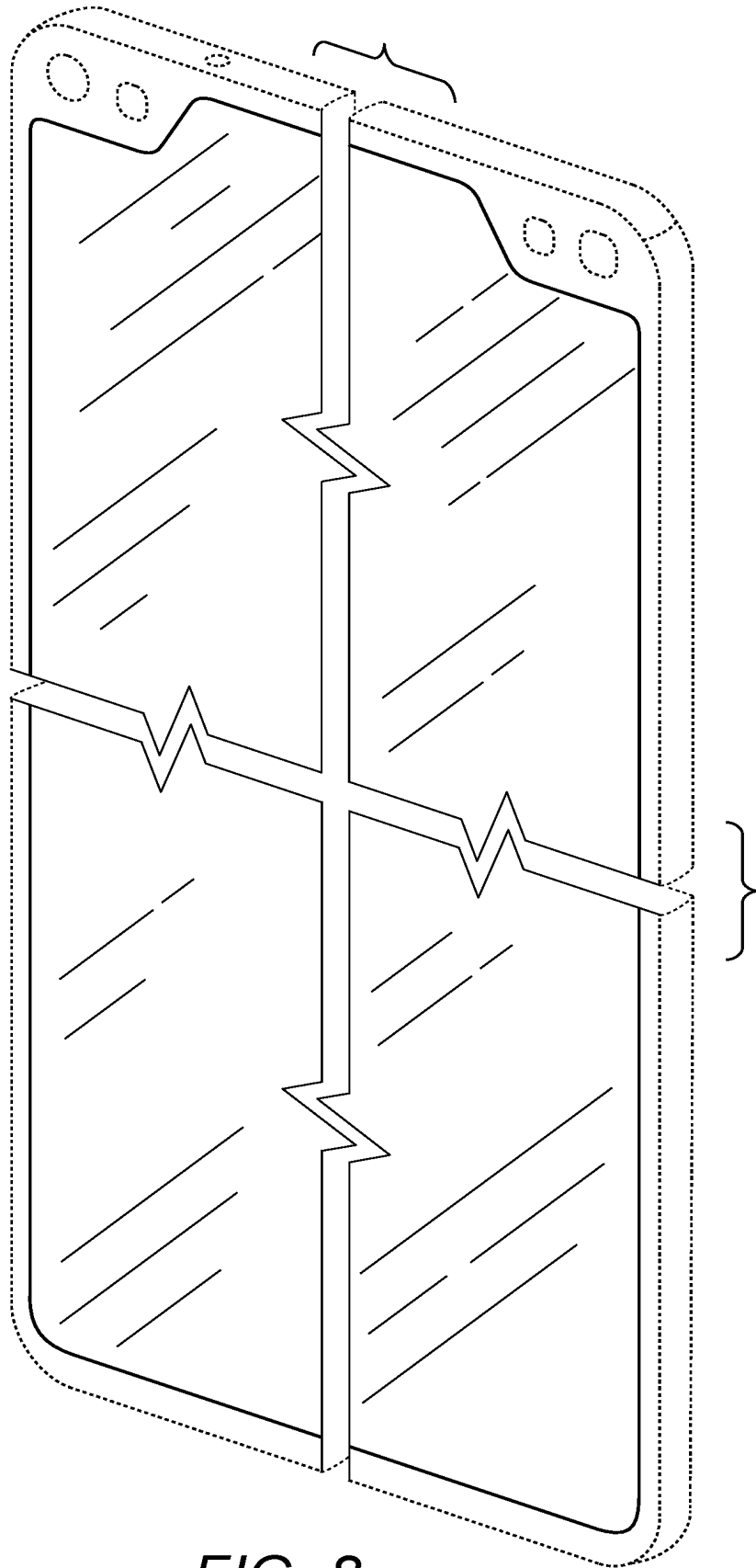

FIG. 8

6/24

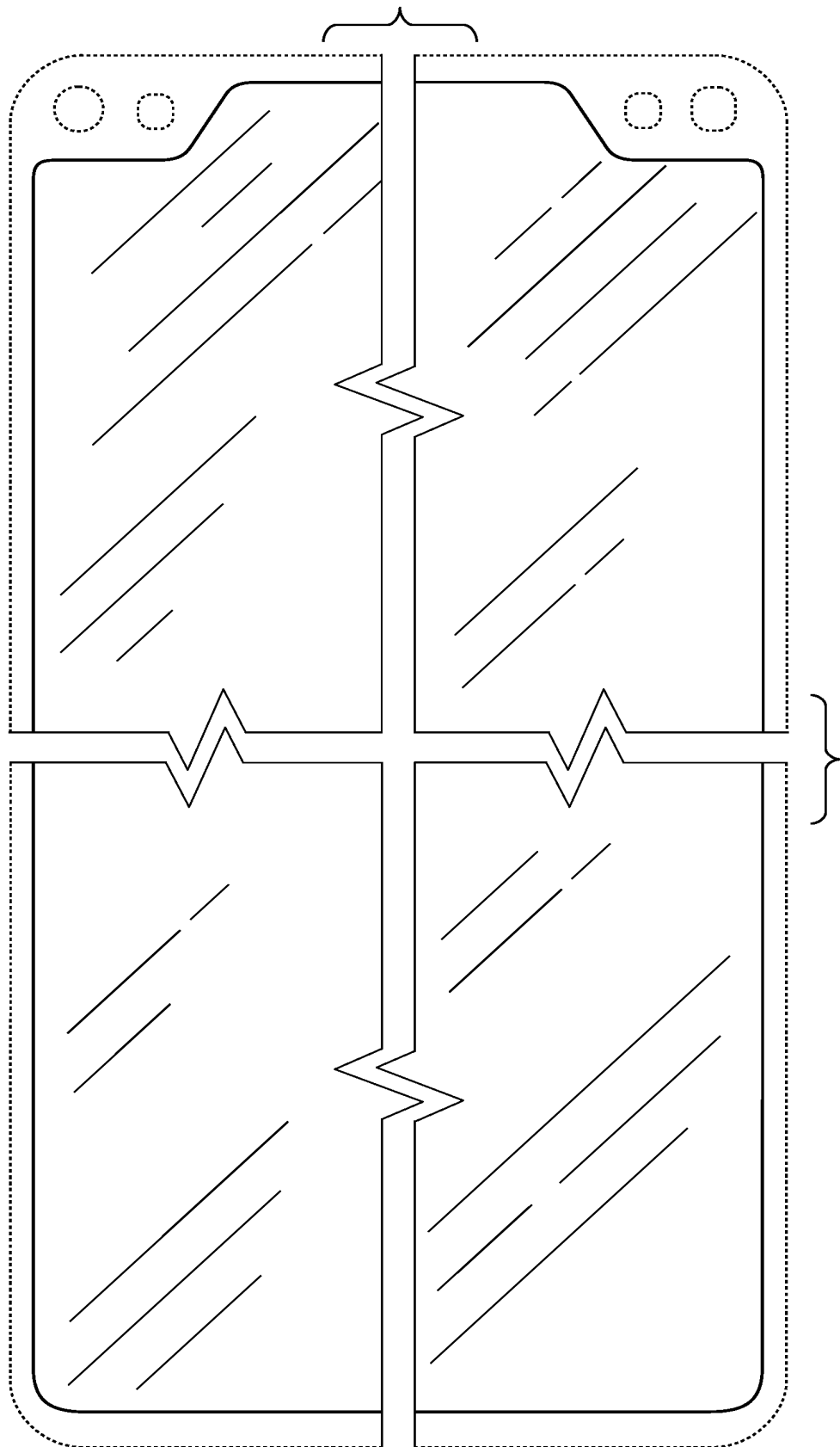

FIG. 9

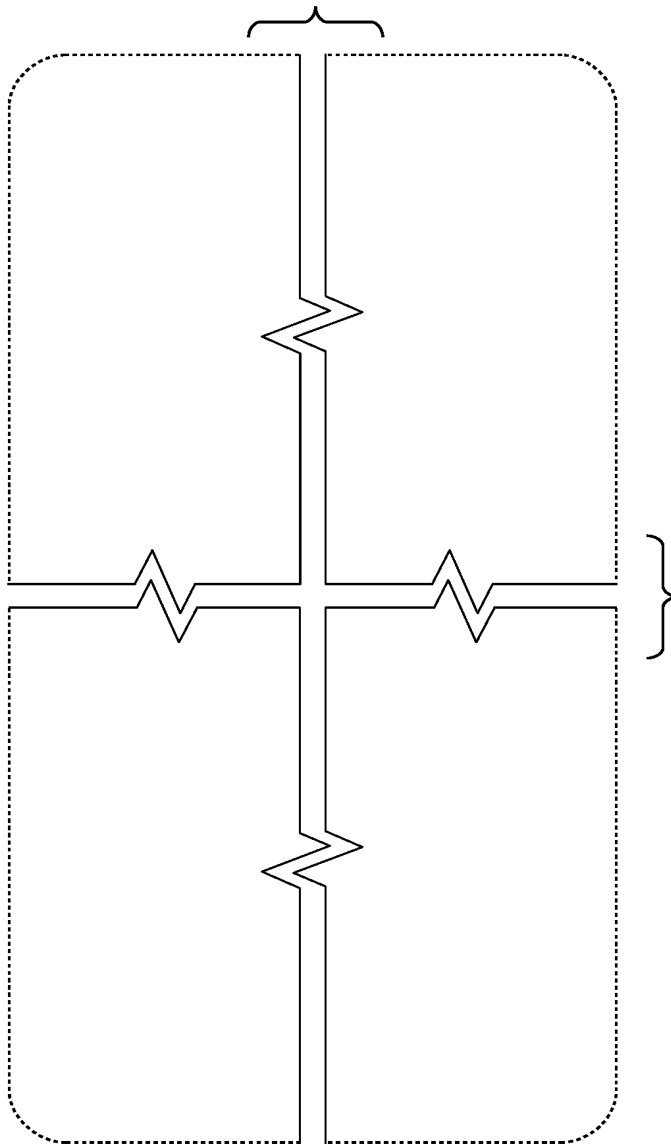

FIG. 10

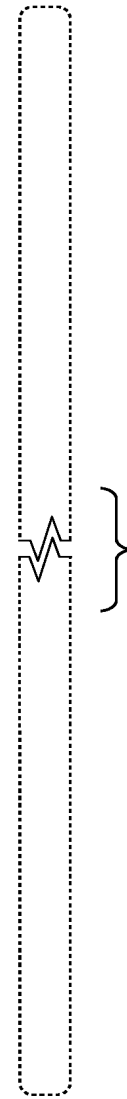

FIG. 11

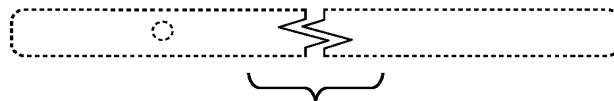

FIG. 12



FIG. 13

8/24

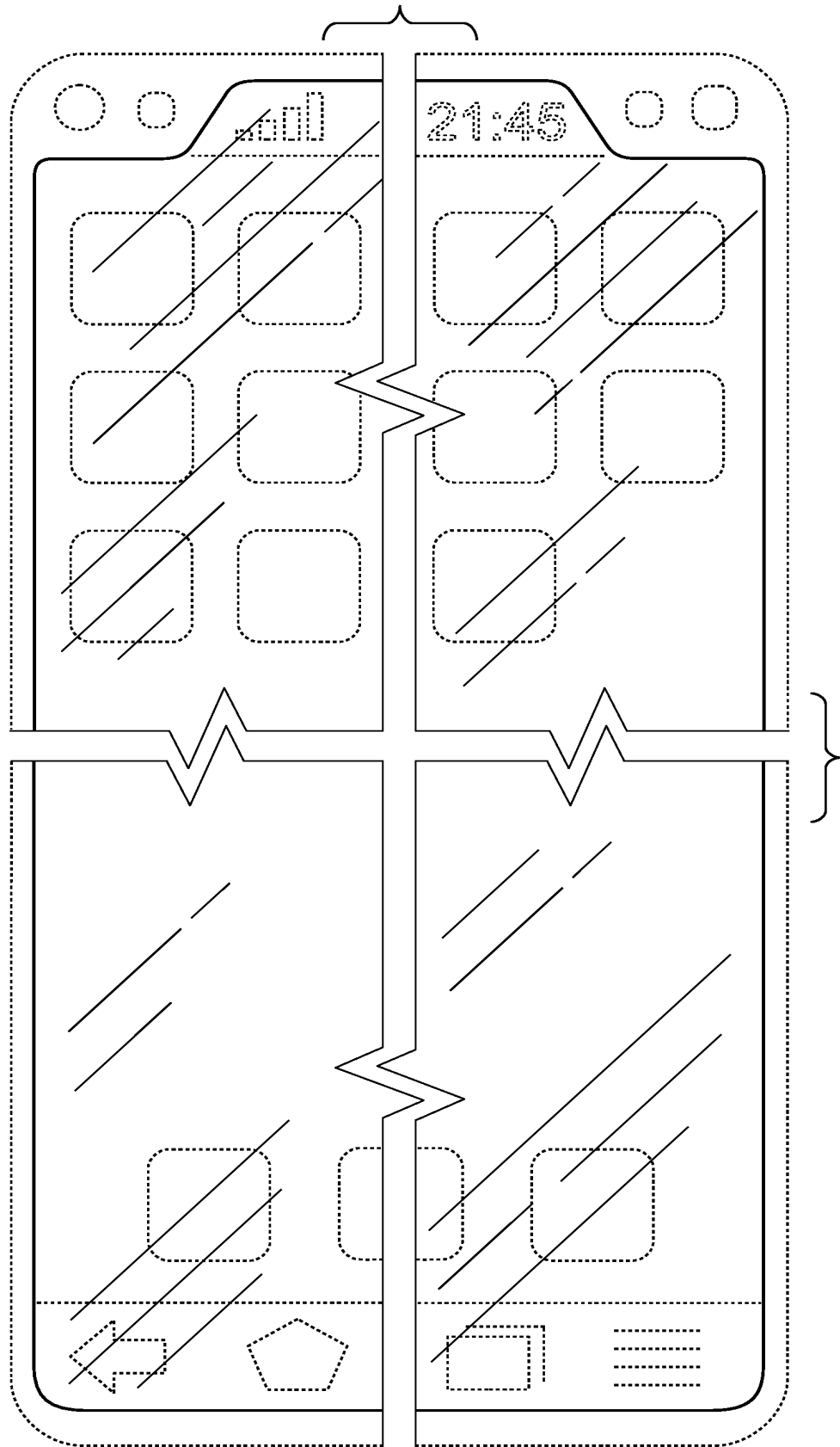

FIG. 14

9/24

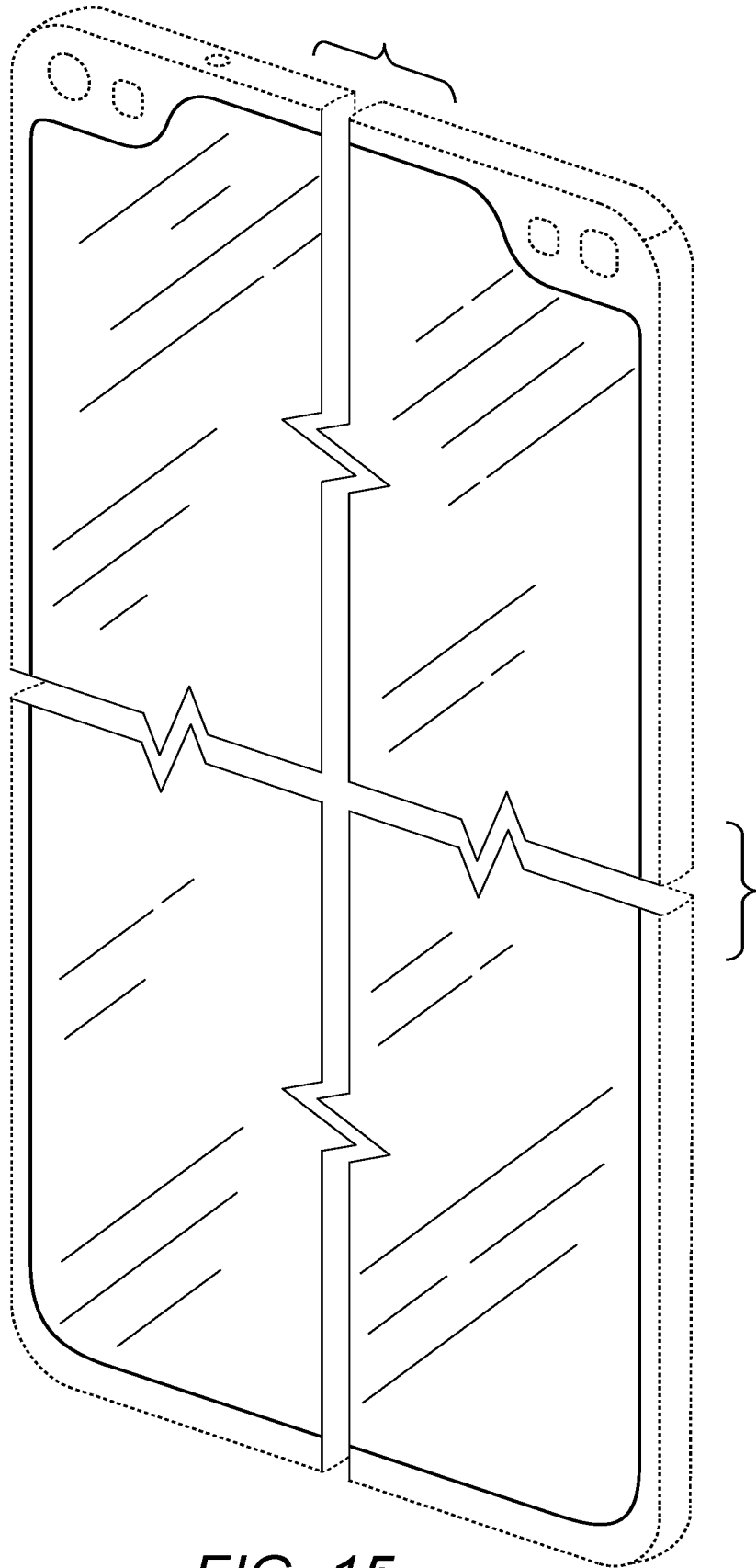

FIG. 15

10/24

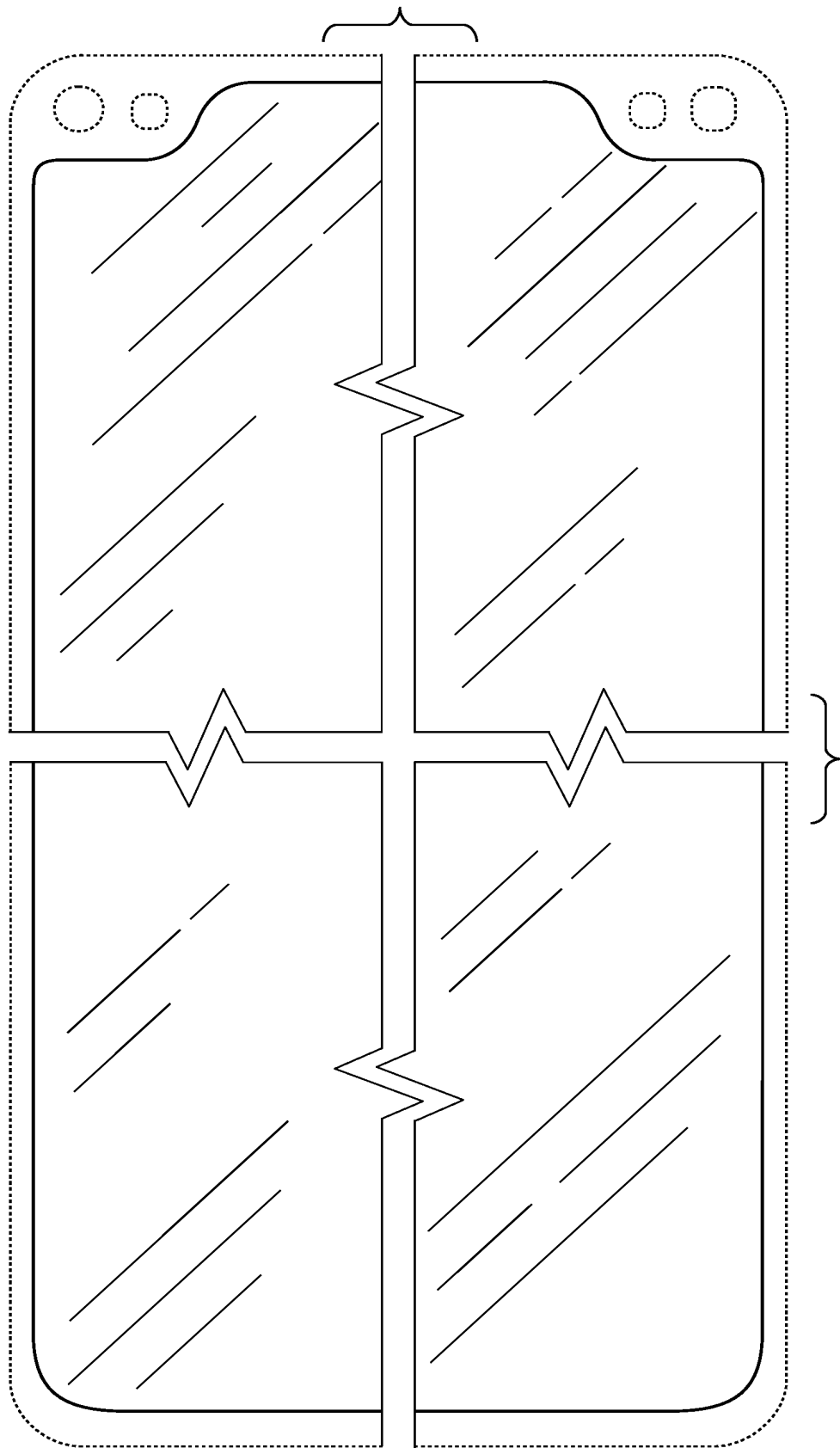

FIG. 16

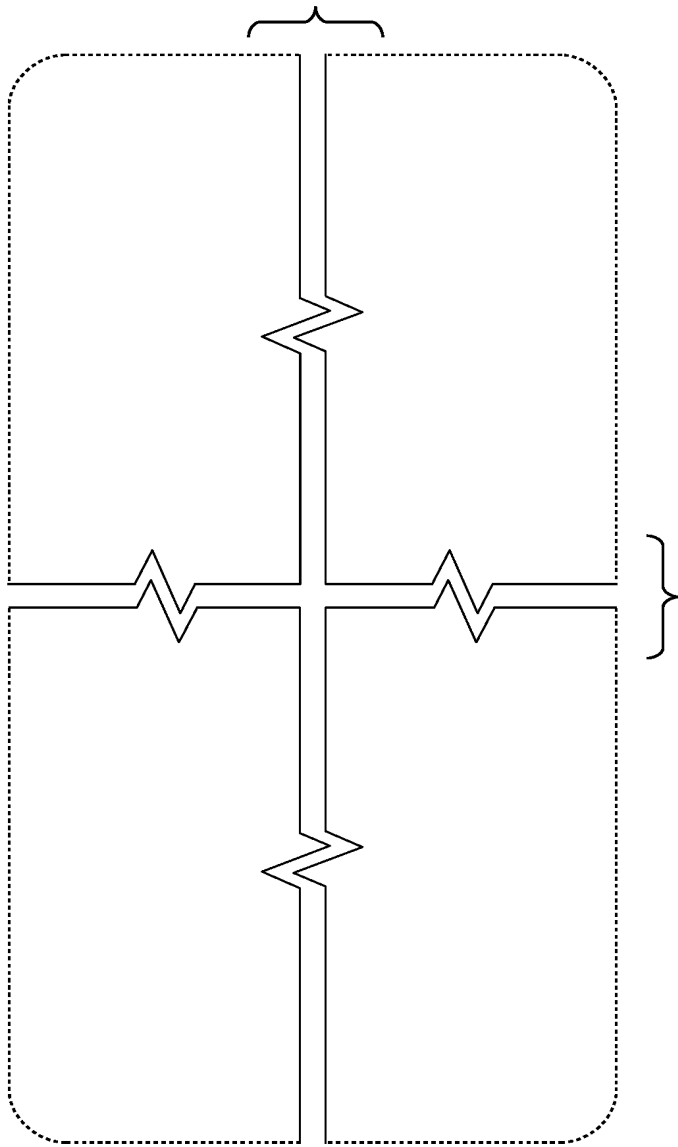

FIG. 17

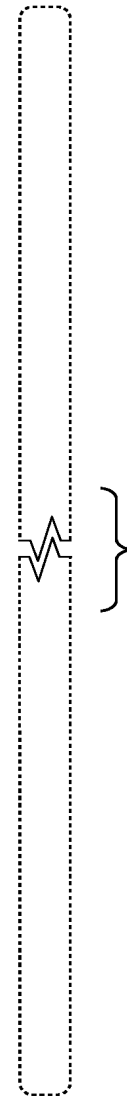

FIG. 18

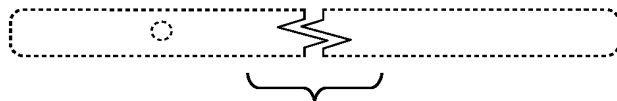

FIG. 19



FIG. 20

12/24

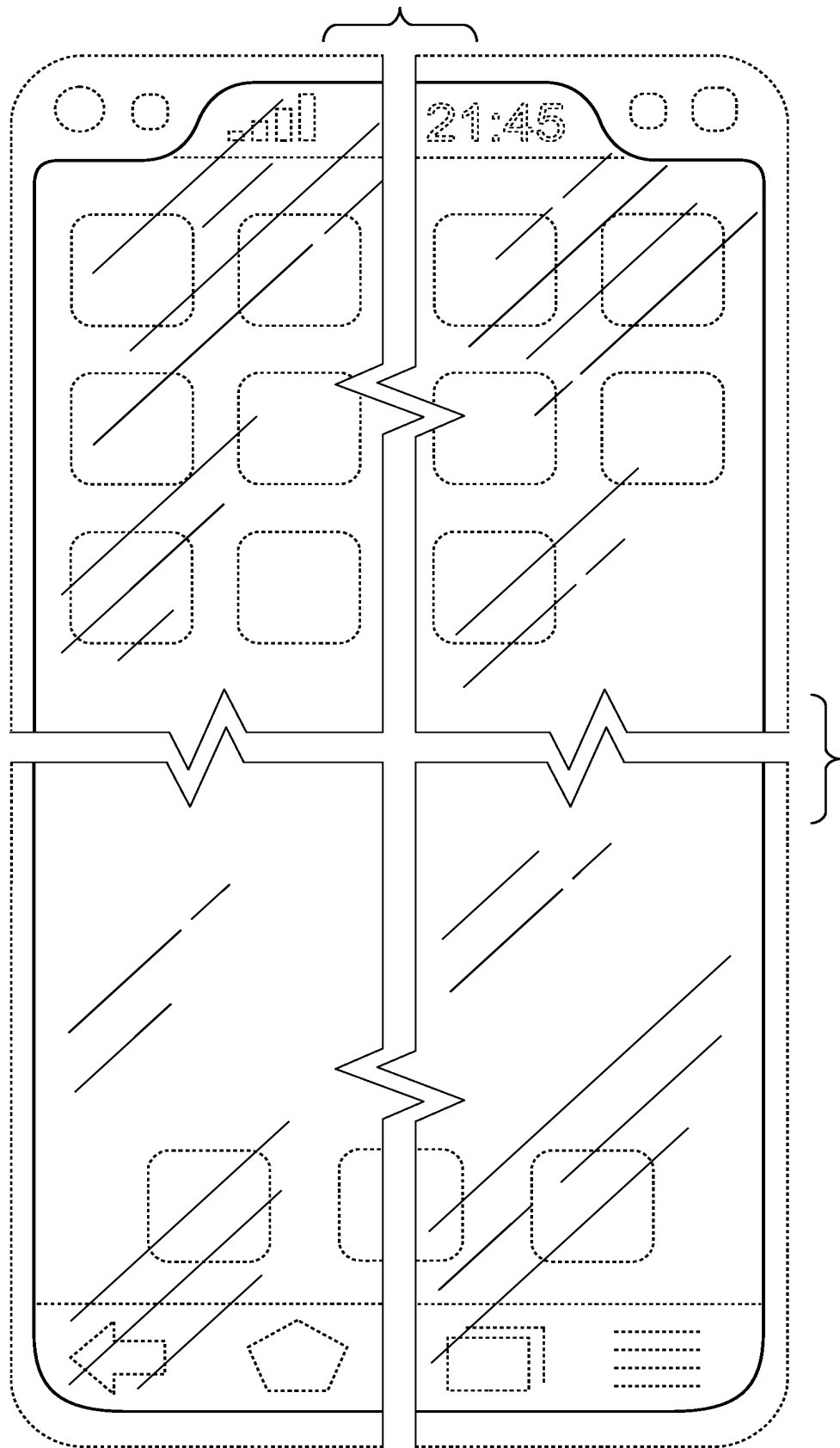

FIG. 21

13/24

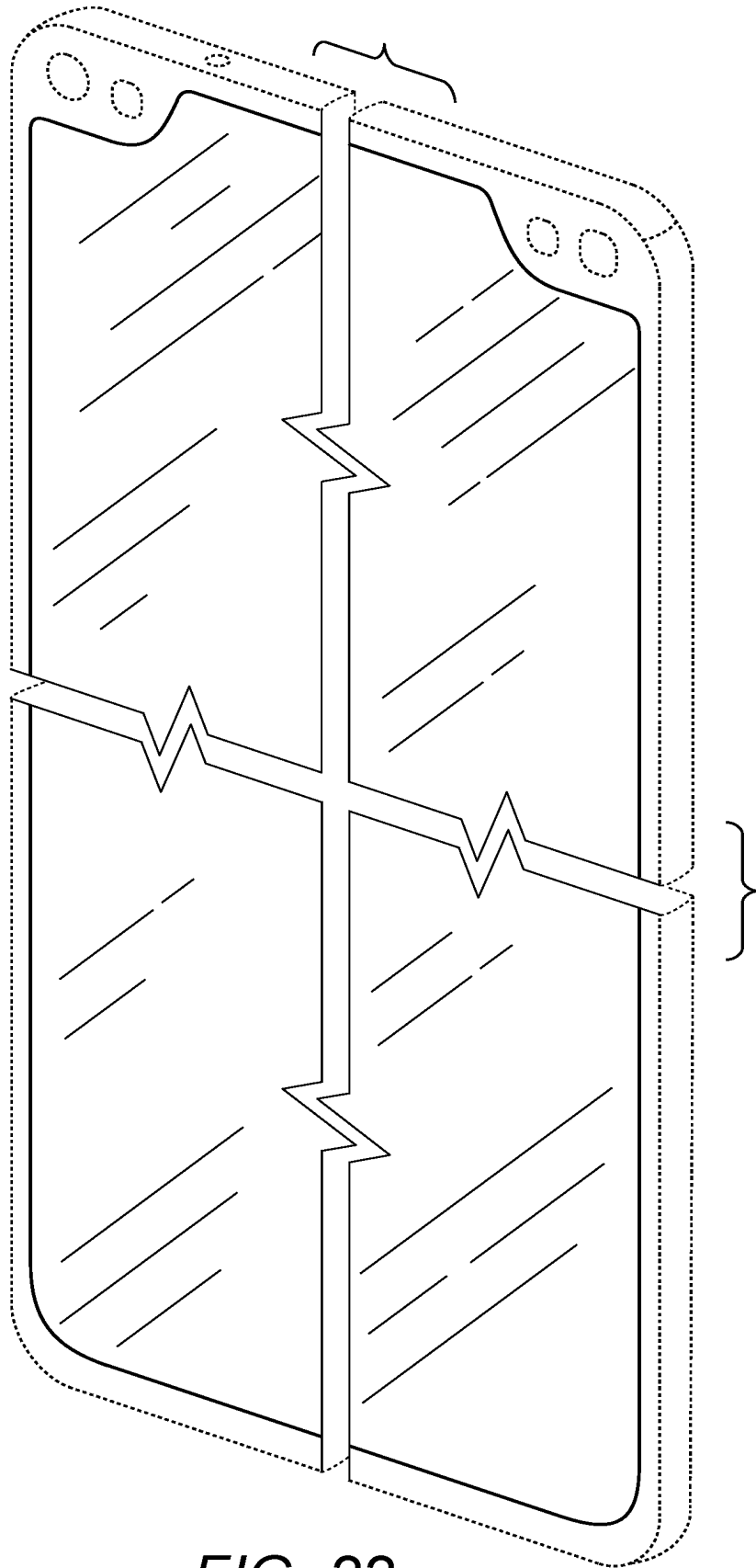

FIG. 22

14/24

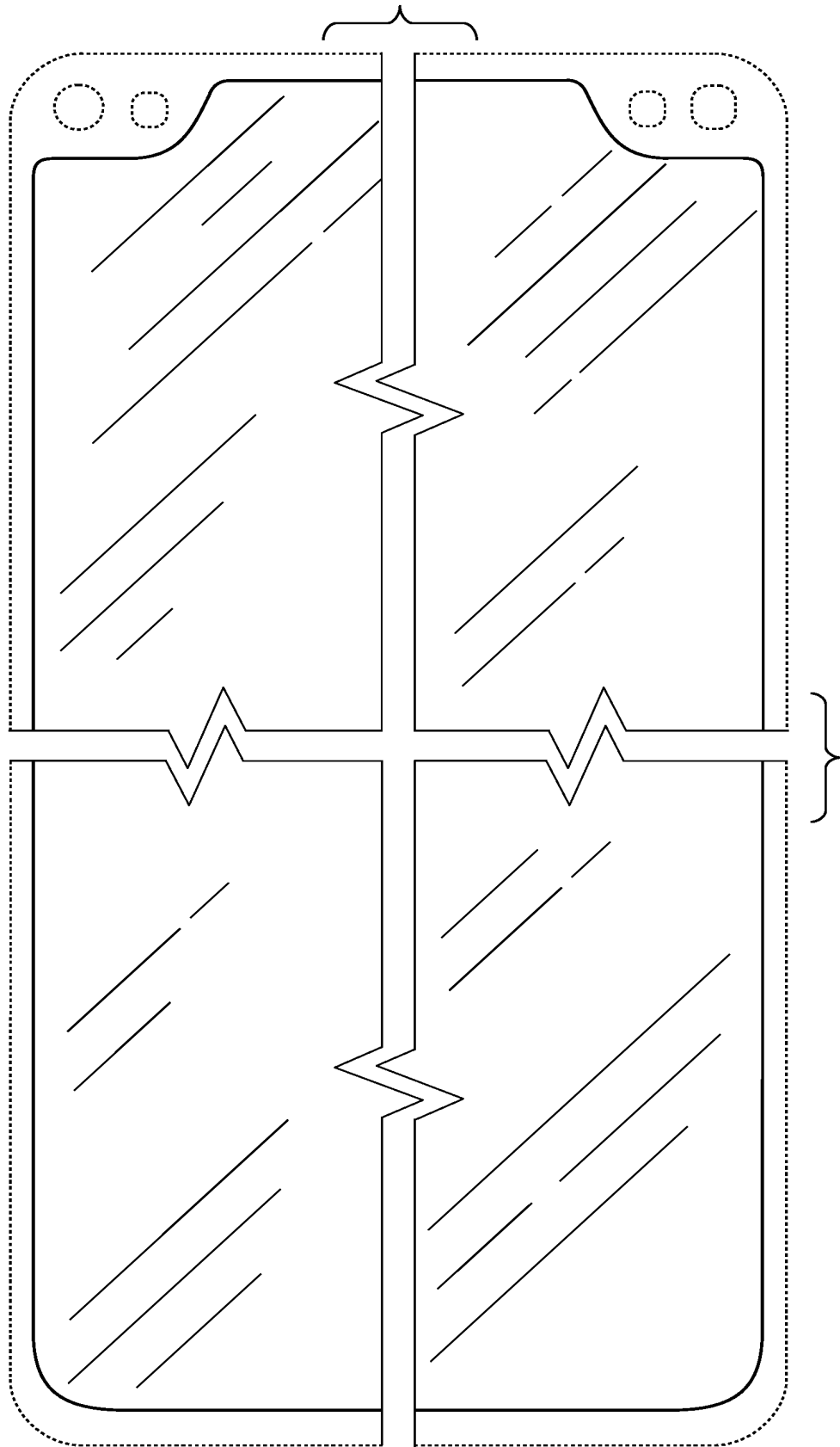

FIG. 23

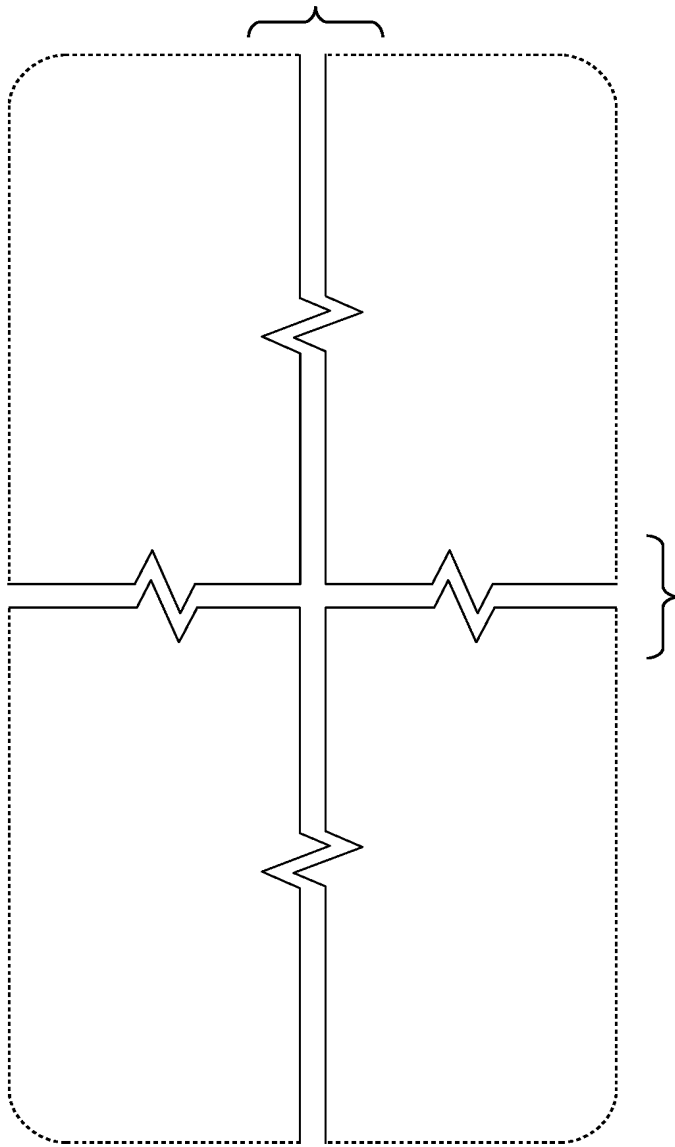

FIG. 24

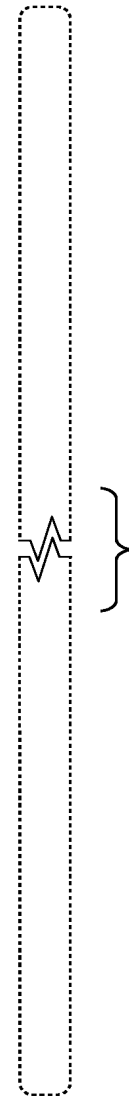

FIG. 25

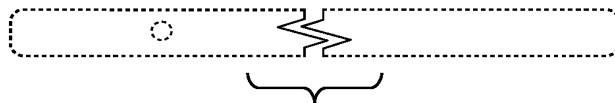

FIG. 26



FIG. 27

16/24

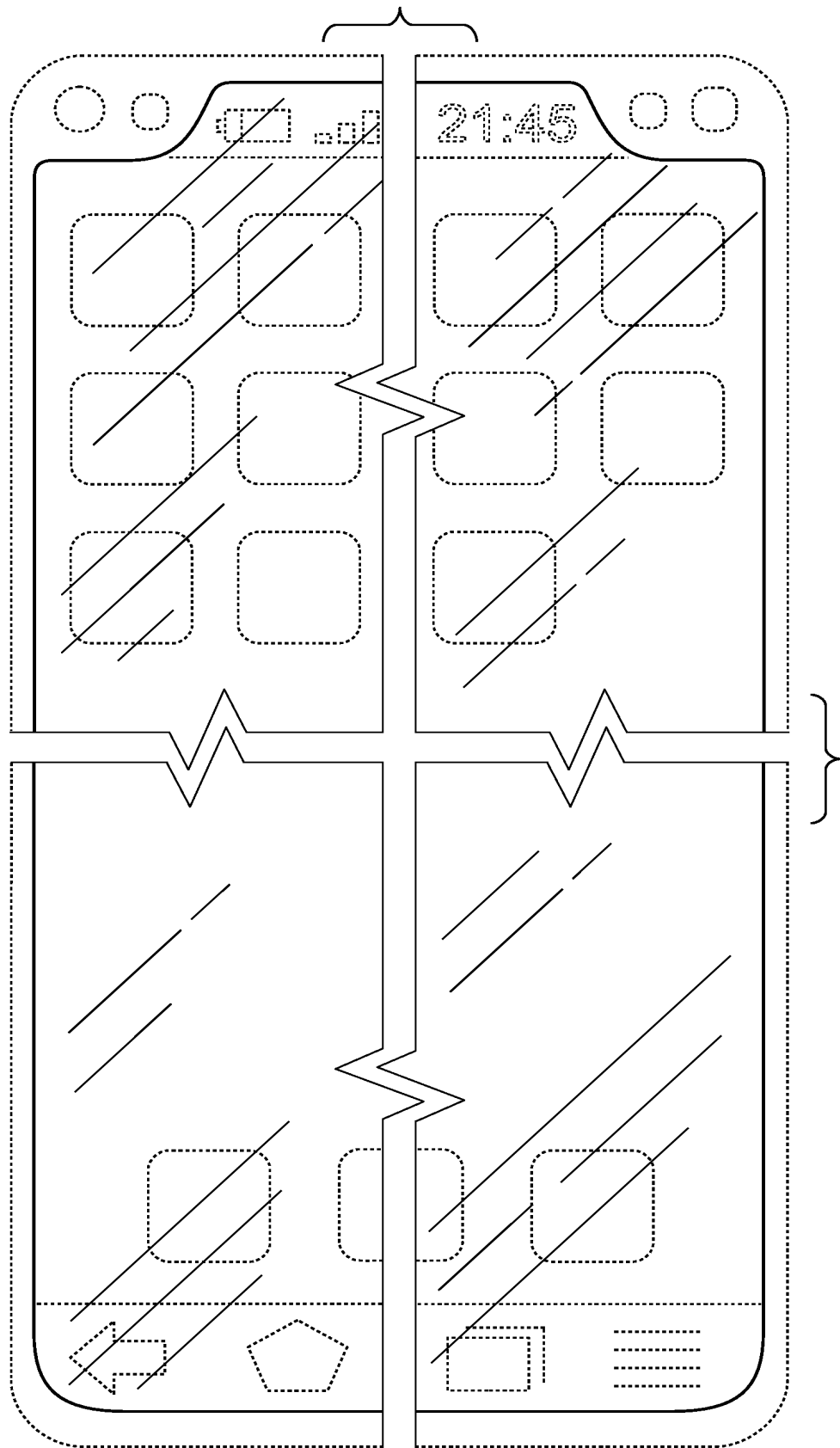

FIG. 28

17/24

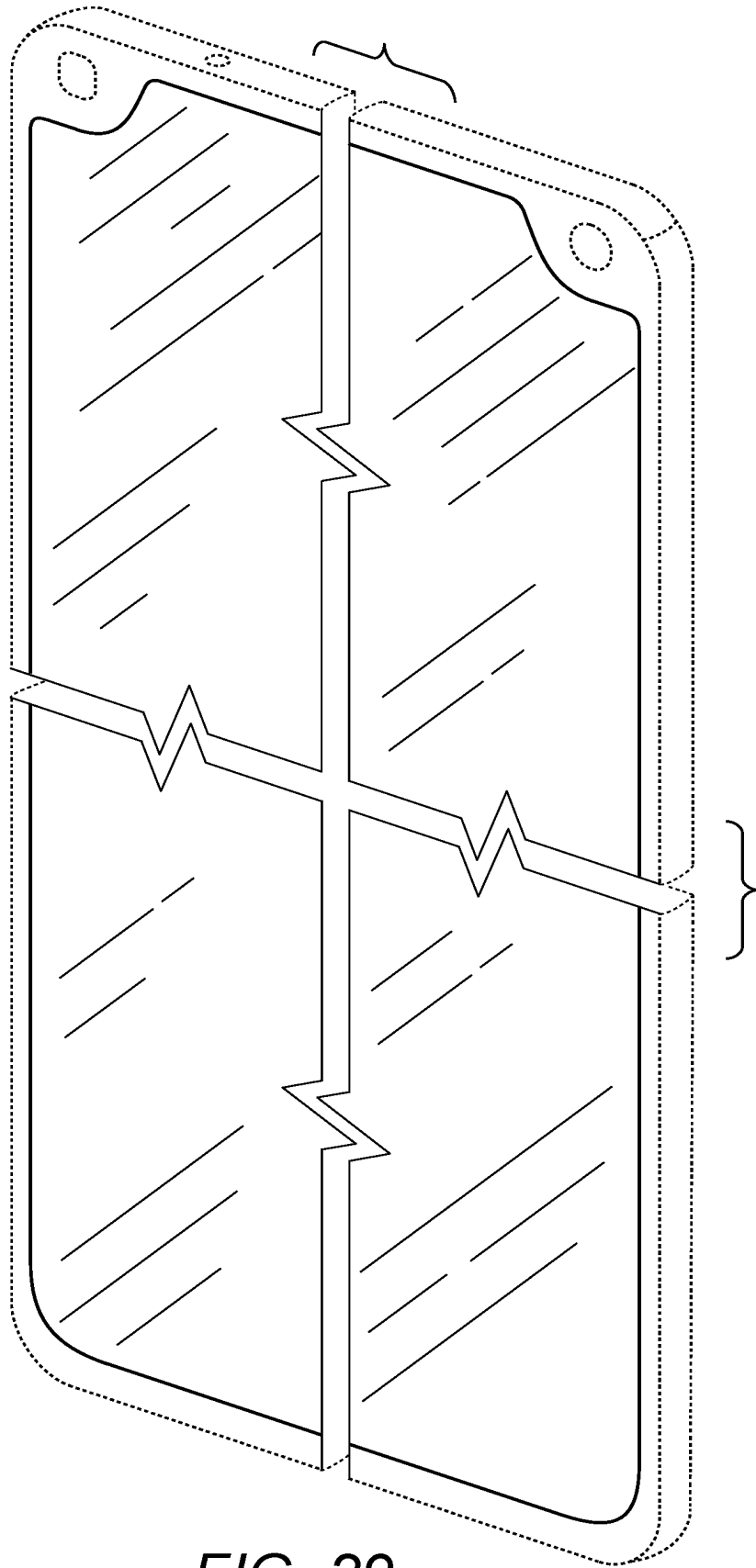

FIG. 29

18/24

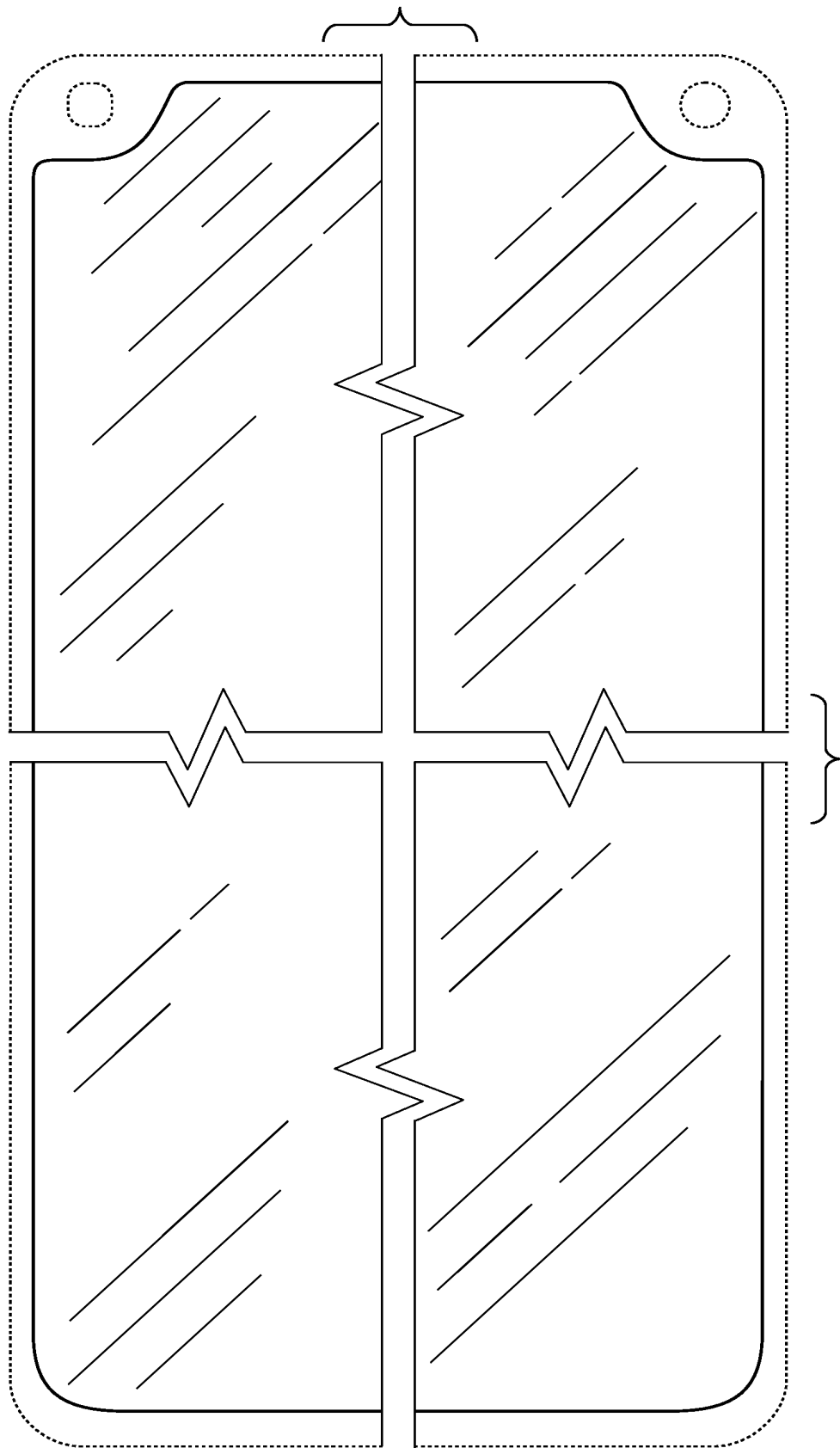

FIG. 30

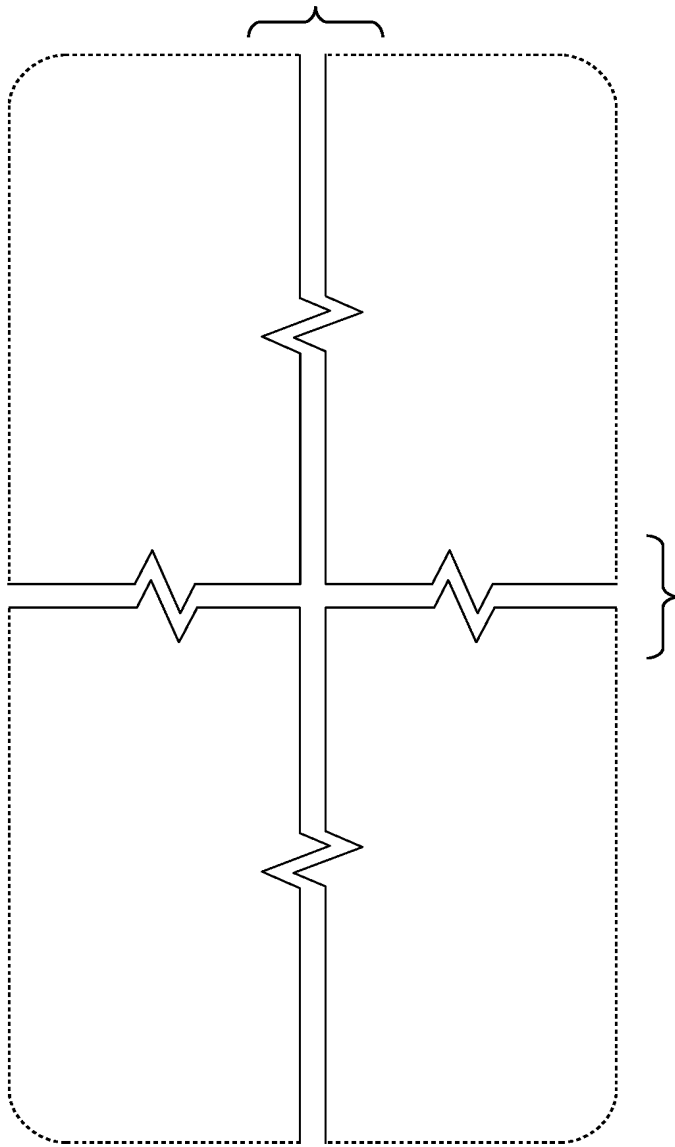

FIG. 31

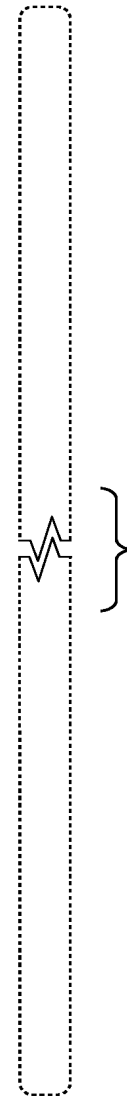

FIG. 32



FIG. 33



FIG. 34

20/24

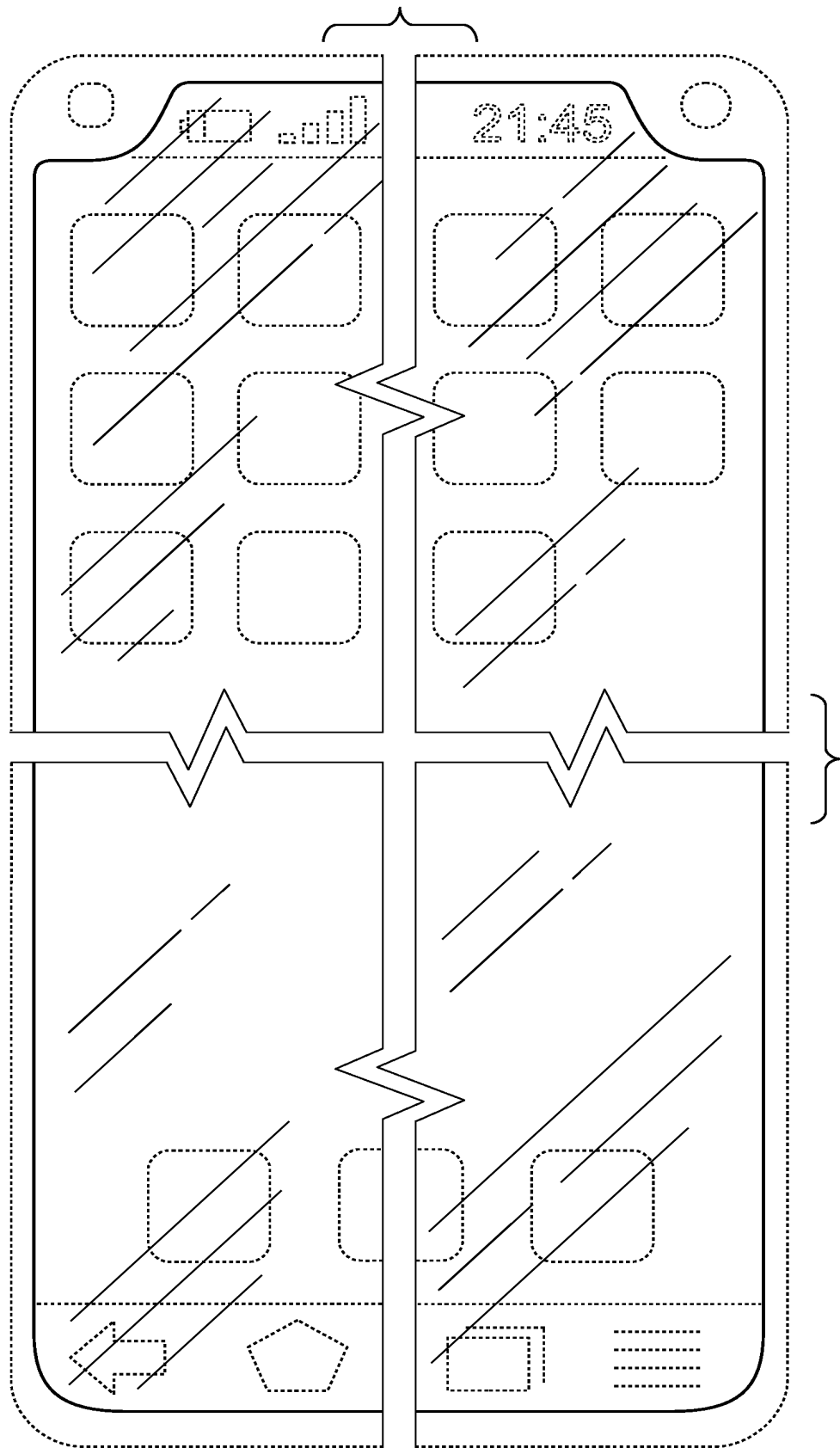

FIG. 35

21/24

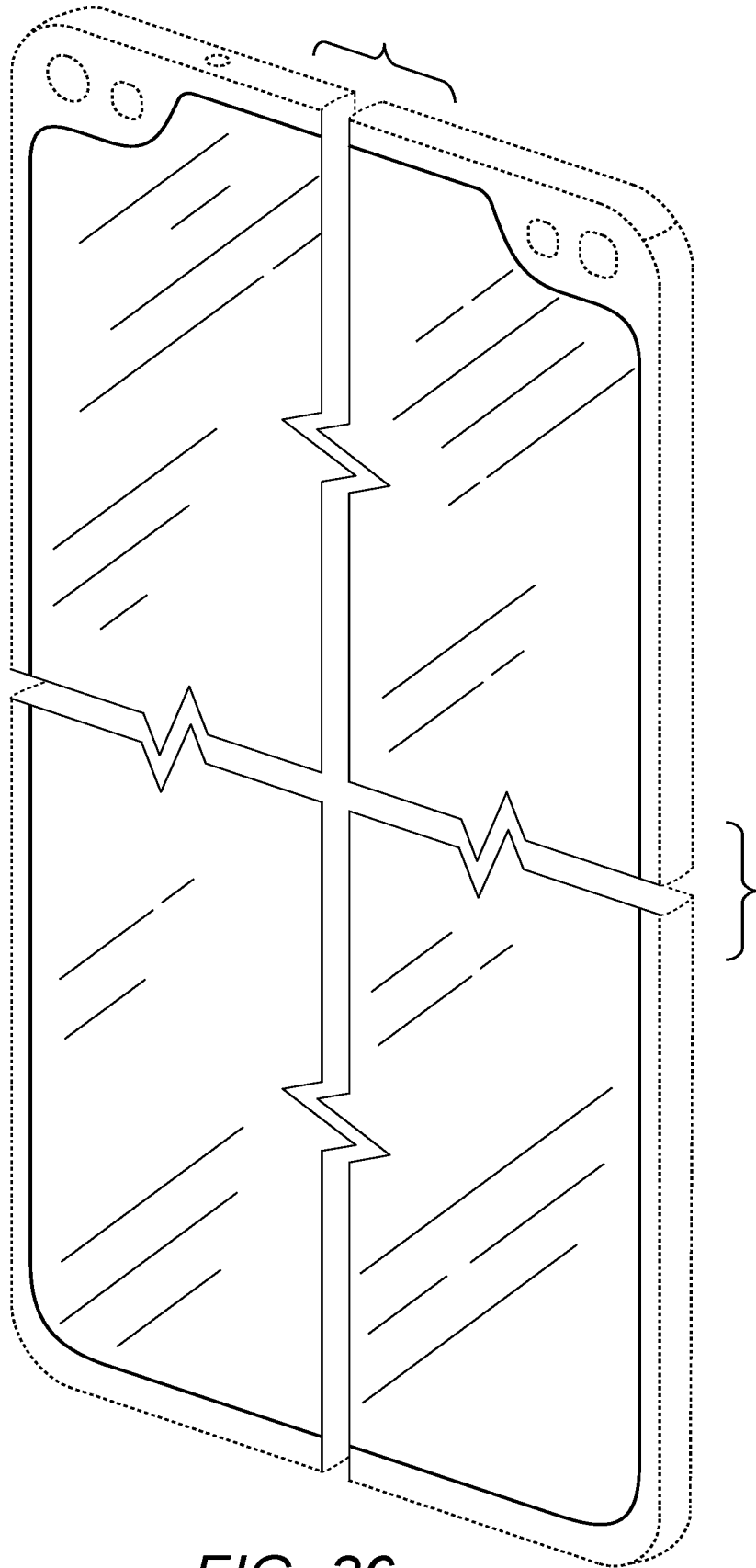

FIG. 36

22/24

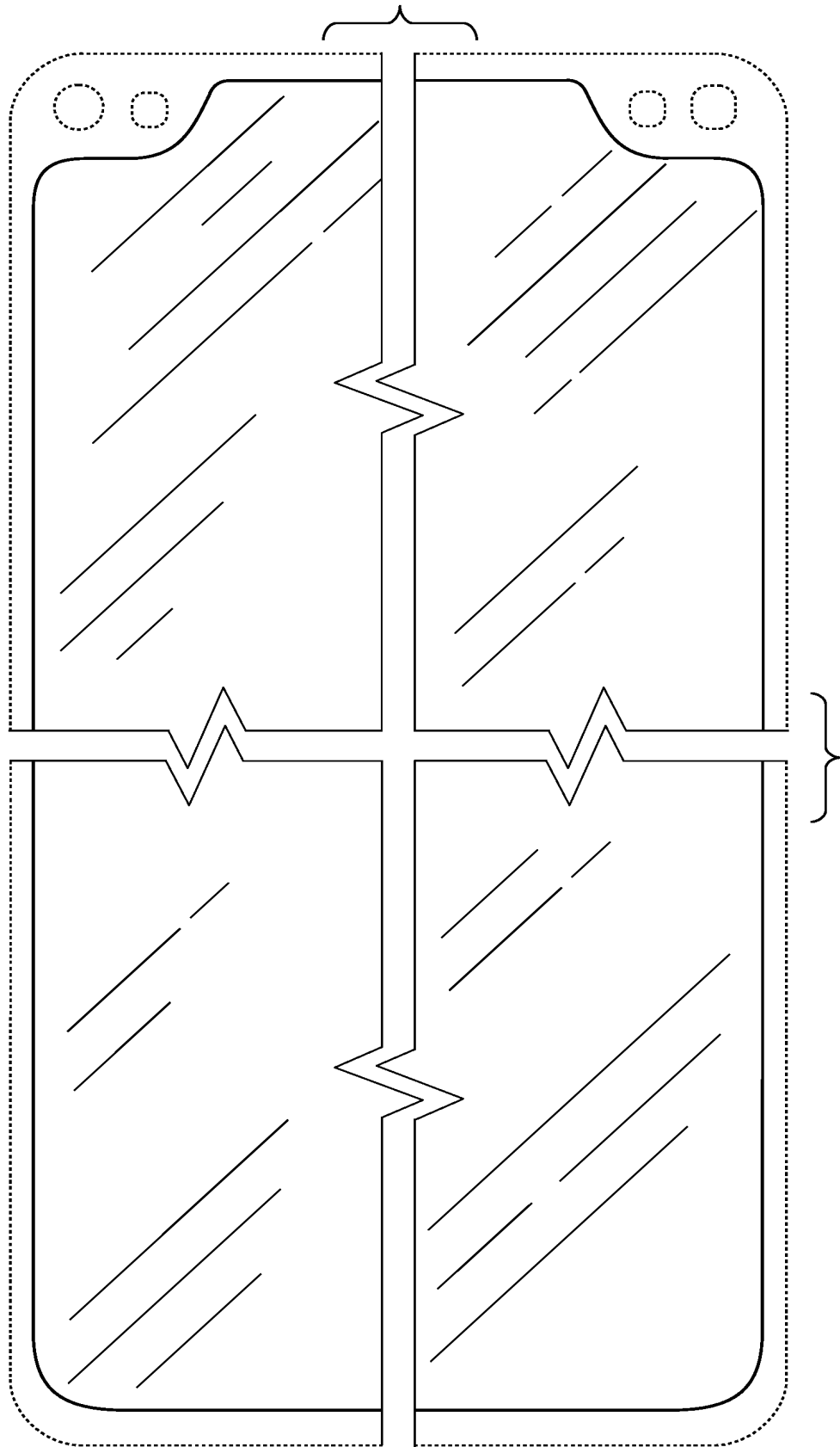

FIG. 37

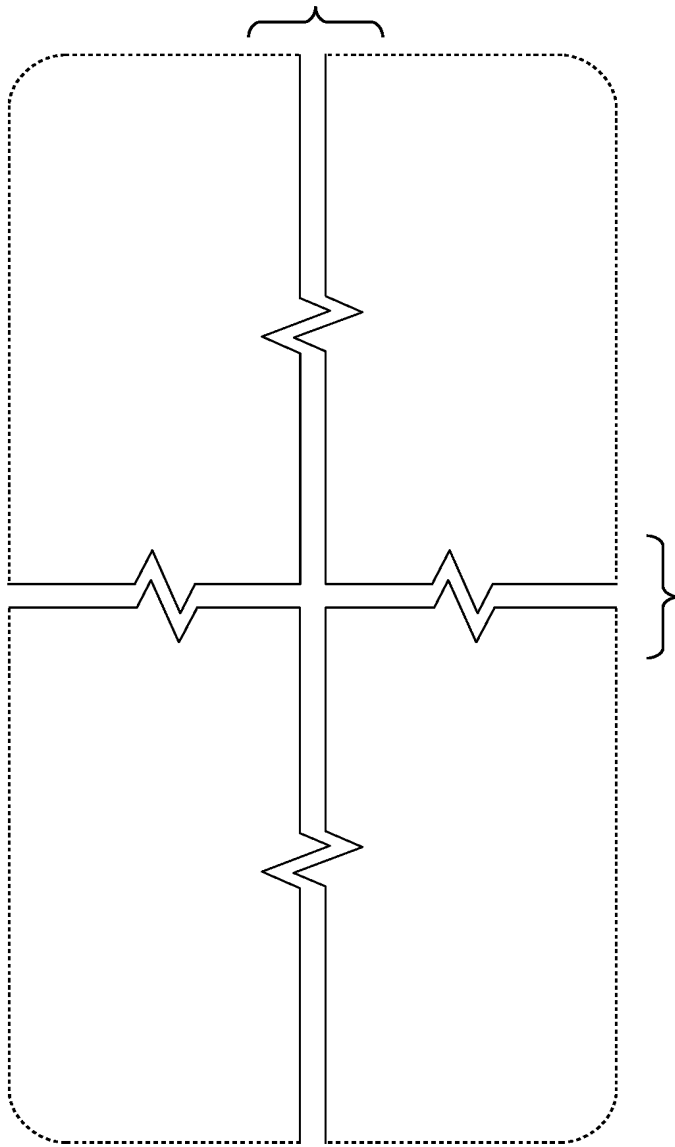

FIG. 38

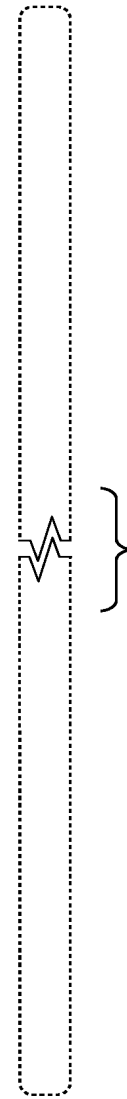

FIG. 39

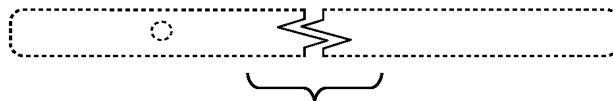

FIG. 40



FIG. 41

24/24

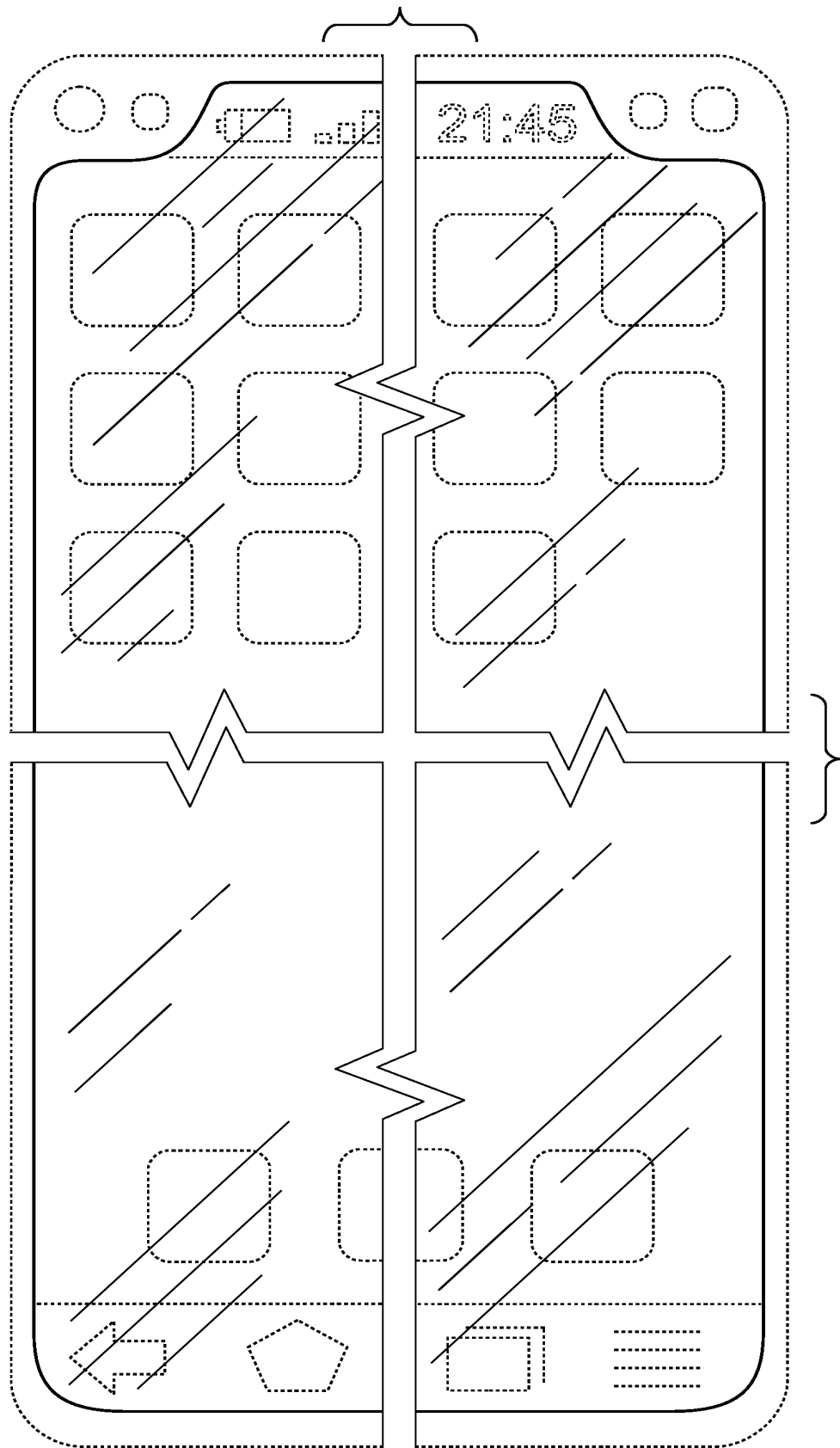

FIG. 42